

PERIODIC DISTURBANCE REJECTION WITH
AN INTERNAL MODEL-BASED H_2 OPTIMAL
CONTROLLER

C.E. Kinney* R.A. de Callafon*,¹ E. Dunens**
R. Bargerhuff** C.E. Bash**

* *Dept. of Mechanical and Aerospace Engineering,
University of California, San Diego, 9500 Gilman Drive,
La Jolla, CA 92093-0411, U.S.A.*

** *Hewlett-Packard Company, 20555 State Highway 249,
Houston, Texas 77070, U.S.A.*

Abstract: In this paper a method is proposed to design an optimal controller that uses an internal model and an additive noise model to reject periodic disturbances. The proposed design method allows for the design of a feedback controller that rejects periodic disturbances in the presence of random noise. An active noise cancellation application for an HP DL380 G3 rack server cooling fan is presented to demonstrate the effectiveness of the proposed design method. System identification techniques are used to find a model of the non-periodic disturbances. The feedback controller was implemented in real-time to show the effectiveness of periodic blade pass frequency sound reduction. *Copyright © 2005 IFAC.*

Keywords: Feedback; Active Noise Control; Disturbance Rejection; Optimal Control; System Identification

1. INTRODUCTION

Many systems that require control exhibit two types of disturbances: periodic and non-periodic. Recently, work in the area of repetitive control (Steinbuch, 2002), (De Roover et al., 2000), (W.S. Chang and Kim, 1995), (Inoue, 1990), (Freeman et al., 2004), (K. Yamada and Arakawa, 2004) has produced good results in the rejection of periodic disturbances. Repetitive controllers can be viewed as an extension of the internal model principle (Francis and Wonham, 1976). An internal model, often called a memory loop, is placed in the feedback loop in order to cancel the repetitive disturbance.

Since the standard memory loop (Steinbuch, 2002) is marginally unstable it is impractical to implement without modification. Typically, two filters are used to modify the memory loop. One

filter is used to create a stable model, and one filter is used to eliminate high frequency components. This method results in a high order internal model that is designed on a trial and error basis. Additionally, non-periodic effects are often left out of the analysis, and the resulting controller can over amplify these components.

In this paper a feedback control algorithm is designed that is able to provide a trade-off between the effects of both the periodic and non-periodic noise components. With this method it is possible to design a controller that emphasizes the elimination of periodic components without over amplifying the non-periodic noise components. The controller can be tuned to reject the periodic disturbances until there is no appreciable difference between the two types of disturbances.

The control design method is used to implement a real-time feedback controller for the Active Noise Control (ANC) of a server cooling fan. A cooling fan exhibits periodic components due to the blade passing frequency (BPF) and non-periodic

¹ Corresponding author. Tel.: +1.858-5343166; Fax: +1.858-8223107; Email: callafon@ucsd.edu

components due to turbulence and vibrations of the fan for which active noise control can be used to reduce the sound emission of the fan, see e.g. (Hu, 1996), (Romeu et al., 2001), (Sawada and Ohsumi, 2001), (Wu and Bai, 2001) or (Y.J. Wong and Pan, 2003).

For the application of ANC on the server cooling fan, the periodic components are attenuated with the use of an internal model. Instead of starting with a standard filtered memory loop, a stable internal model is used directly in the feedback controller design to reject specific deterministic disturbances. Using standard H_2 control theory, periodic and non-periodic disturbances are incorporated into the design. In this manner, a low order controller can be designed that uses an internal model and a stochastic model to eliminate periodic disturbances in the presence of random noise.

2. ACTIVE NOISE CONTROL FOR A COOLING FAN

2.1 ANC System

The ANC application discussed in this paper consists of five main components: an internal pick-up microphone (an omnidirectional electret microphone), actuator (1.1" miniature speaker), fan mounting (polyurethane acoustical foam and acrylic), digital controller (Pentium based P.C. with a MultiQ3 12 bit signed AD/DA card), and a HP DL380 G3 rack server cooling fan. Figure 1 on the left shows the cooling fan without the speaker and microphone. Figure 1 on the right shows the speaker and microphone mounted to the fan. The internal microphone is used to measure the fan noise, whereas the speaker mounted in close proximity of the fan is used to create the appropriate sound signal to cancel the unwanted noise of the fan. The mounting holds the internal microphone and speaker in close proximity of the fan.

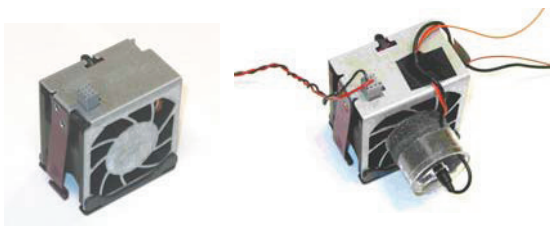

Fig. 1. Left: Server cooling fan. Right: ANC system used to cancel unwanted fan noise.

The dynamic behavior of the sound propagation between the speaker and the microphone is important for a stable design of a feedback active noise control algorithm. By means of dynamic experiments with the speaker and the use of System Identification techniques (Ljung, 1999), a discrete time dynamic model $G(q)$ is estimated that is used to model the sound propagation between the speaker and the microphone and a Bode response of the model $G(q)$ is shown in Figure 2.

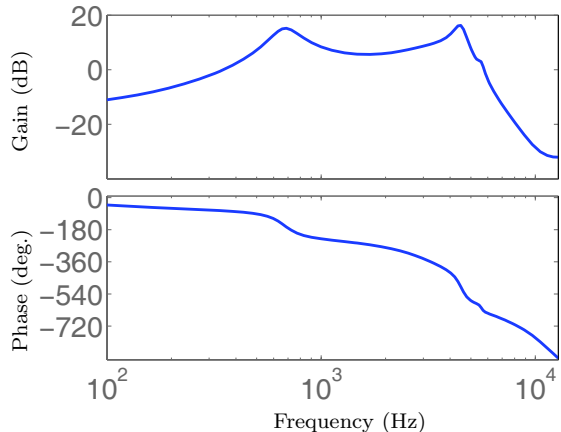

Fig. 2. Amplitude (top) and phase (bottom) Bode plot of the discrete time model $G(q)$ used to capture the dynamics between the speaker and the pick-up microphone.

2.2 Fan Noise

The characteristics of the noise of the fan, as measured by the microphone, is shown in Figure 3. It can be observed from Figure 3 that there are two distinct types of disturbances. One is periodic; the peaks in the spectral estimate at evenly spaced frequencies of approximately 1000 Hz are harmonics of the BPF. The other disturbance component is the non-periodic noise of the fan due to turbulence and vibrations of the fan.

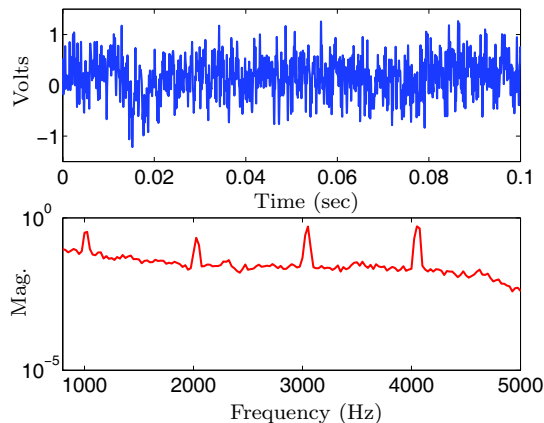

Fig. 3. Pick-up microphone data: time trace (top) and spectral estimate (bottom).

3. DISTURBANCE MODELING FOR CONTROL DESIGN

For the minimization of the effect of disturbances via active feedback control, it is imperative to use a noise model that captures the spectral characteristics of the noise for the computation of an optimal H_2 controller. For systems with both periodic and non-periodic disturbances, Figure 4 indicates how both disturbances components can be modeled. The non-periodic or random disturbances are modeled as colored noise, where $v_n(t)$ is a random process driven by white noise $e(t)$ that

is filtered by a stable and stably invertible filter $H_n(q)$.

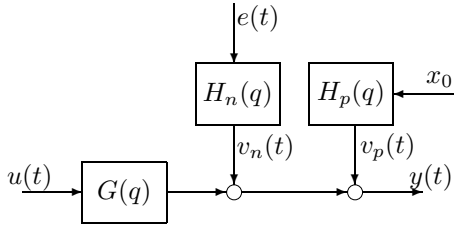

Fig. 4. Block diagram of additive periodic and non-periodic disturbance modeling.

For the modeling of pure periodic components, a n -tap memory loop (Steinbuch, 2002) $H_p(q)$ with an unknown initial condition x_0 can be used. An n -tap memory loop is a unity positive feedback system of a time delay of n discrete time steps in which the transfer function $H_p(q)$ is given by

$$H_p(q) = \frac{q^{-n}}{1 - q^{-n}}. \quad (1)$$

When added together, $v_n(t)$ and $v_p(t)$ can produce a spectral amplitude plot similar as in Figure 3.

Unfortunately, the design of optimal feedback algorithms that include the additive noise model $H_n(q)$ and $H_p(q)$ will lead to a high order controller. This is mainly due to large number of taps n in (1) for a low frequent periodic disturbance in a high frequency sampled discrete-time systems. Furthermore, $H_p(q)$ will have an infinite gain at every $\frac{f_s}{n}$ Hz, theoretically requiring an infinite controller gain for periodic disturbance cancellation. Adding additional filtering or placing the poles of $H_p(q)$ inside the unit circle will only partially address these problems.

Instead of using $H_p(q)$ directly, a simplified model $W_i(q)$ will be used to cancel the effect of periodic components. The model $W_i(q)$ will act as an internal model during the control design, reducing the main periodic components of the disturbance modeled in $H_p(q)$ to the same level as the non-periodic components modeled by $H_n(q)$.

4. CONTROLLER DESIGN

4.1 Internal Model Approach

Francis and Wonham (Francis and Wonham, 1976) showed that the purpose of the internal model principle is to place closed loop transmission zeros where the unstable poles of the disturbance is located. This placement of the closed loop transmission zeros gives a robust controller that asymptotically rejects periodic disturbances.

The complete rejection of periodic disturbances in a closed loop system has a price; disturbances at other frequencies are often amplified. This result may be acceptable in systems with periodic disturbances only, but in systems with random and periodic disturbances this result can amplify random

disturbances beyond acceptable levels. Instead of completely rejecting the period disturbances, the objective is to reduce their amplitude to the same level as the random disturbances.

This reasoning leads to the use of an internal model $W_i(q)$ that is a low-order approximation of $H_p(q)$, next to the additive noise model $H_n(q)$ that captures the broadband power spectral density of the disturbance. $W_i(q)$ is used only to cancel the main periodic components of the disturbance and is used as a weighting filter in the control design. As such, $W_i(q)$ is designed to eliminate specific deterministic components. Notch filters, lightly damped harmonic oscillators, and other similar methods can be used. $W_i(q)$ must be stable and have a power spectral density that is similar in shape to the periodic disturbance present in the system.

There are several benefits of using an internal model. First, it is well known that the use of internal model can result in a controller that rejects periodic disturbances. Secondly, the implemented controller is the internal model times the designed controller $K(q)$. This structure allows for simple adaptive control. If the controller $K(q)$ is robust against variations in $W_i(q)$, and $W_i(q, \omega_1)$ is parameterized in terms of the first harmonic frequency ω_1 of the periodic disturbance, then online identification of the first harmonic and adaptation of $W_i(q, \omega_1)$ will result in an adaptive controller. This methodology is very simple since only one parameter is estimated and modified.

4.2 Standard Two Block Problem

For the standard two block problem, see Figure 5, where $G(q)$ is the plant, $H(q)$ is output additive noise model, $e(t)$ is a white noise process with mean zero and variance λ , $[z_1(t) \ z_2(t)]$ is the optimization vector, and α as the control weighting, the controller $K(q)^*$ is defined as

$$K(q)^* := \arg \min_{K(q)} \left\| \frac{\frac{\alpha K(q)H(q)}{(1 - G(q)K(q))}}{\frac{H(q)}{(1 - G(q)K(q))}} \right\|_2, \quad (2)$$

where $\|\cdot\|_2$ is the H_2 norm. For $\alpha = 0$, the so-called minimum variance controller (Astrom and Wittenmark, 1990), (Goodwin and Sin, 1984) is found. Weighting the control energy with at least a scalar gain, allows for the design of controllers that are stable and limit the control energy during ANC.

One method of designing an internal model-based controller would be to design $K(q)^*$ as in (2), but for the augmented plant $G(q)W_i(q)$ and the noise model $H_n(q)$ that models the non-periodic components only. This gives the following optimal control problem:

$$K(q)^* := \arg \min_{K(q)} \left\| \frac{\frac{\alpha W_i(q)K(q)H_n(q)}{(1 - G(q)W_i(q)K(q))}}{\frac{H_n(q)}{(1 - G(q)W_i(q)K(q))}} \right\|_2. \quad (3)$$

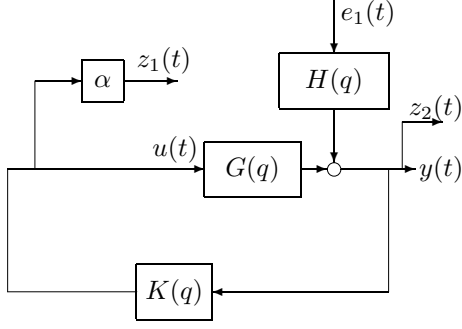

Fig. 5. Standard H_2 optimal control two-block problem, where $H(q)$ is the noise model and α is the control weighting.

If $W_i(q)$ is minimum phase, let $\alpha = 0$ and consider the choice

$$K(q) = W_i(q)^{-1} \overline{K(q)}. \quad (4)$$

then inserting (4) into (3) gives (2) (for the minimum variance controller). It can be seen from this example that the controller designed in (3) will be the same as the controller designed in (2), for $\alpha = 0$, and thus the internal model does not effect the control design as is desired. To overcome this effect, a modified two block problem is presented in the following section.

4.3 Two Block Problem with an Internal Model

The augmented plant shown in Figure 6 is used to design the optimal controller. $K(q)$ minimizes the H_2 norm of the transfer function matrix between $e(t)$ and $[z_1(t) \ z_2(t)]^T$.

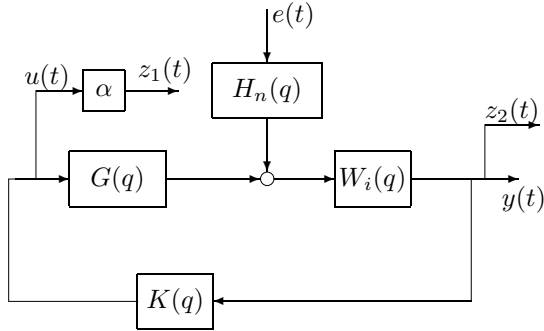

Fig. 6. The two block problem with an internal model that is used for optimal control design.

In Figure 6 the signals $e(t)$ and $[z_1(t) \ z_2(t)]^T$ are chosen such that the control energy weighted by α and the output perturbed by the $H_n(q)$ filtered noise will be minimized. Additionally, the internal model $W_i(q)$ is placed in the path from $e(t)$ to $y(t)$ to incorporate the effect of periodic disturbances. The control design of the modified two block control problem in Figure 6 is given by

$$K(q)^* := \arg \min_{K(q)} \left\| \begin{array}{c} \frac{\alpha W_i(q) K(q) H_n(q)}{(1 - G(q) W_i(q) K(q))} \\ \frac{H_n(q) W_i(q)}{(1 - G(q) W_i(q) K(q))} \end{array} \right\|_2. \quad (5)$$

and can be solved by standard H_2 -norm optimal control techniques.

When the internal model is included as part of the plant, as in (3), the minimum variance controller will invert the internal model. Thus the loop gain will not have the desired structure. Placing the internal model, as in (5), circumvents the problem encountered when designing an internal model-based controller with an augmented plant in the standard two block form. That is, the minimum variance controller will not contain the inverse of the internal model, thus giving a loop gain with the desired structure for periodic disturbances attenuation.

5. ACTIVE NOISE CONTROL RESULTS

5.1 Non-Periodic noise modeling

To model the non-periodic disturbance of the noise, an Auto Regressive (AR) model $H_n(q)$ is used. To accurately estimate the AR model, the signal $y(t)$ of the pick-up microphone is filtered by a filter $F(q)$

$$y_f(t) = F(q)y(t), \quad F(q) = \frac{1 - q^{-25}}{q^{-25}}. \quad (6)$$

and resembles the inverse of $H_p(q)$ in (1) for $n = 25$. The filter $F(q)$ in (6) removes the periodic components so that the AR model only captures the non-periodic components of the disturbance.

The AR model

$$y_f(t) = \frac{1}{A(q, \theta)} e(t) \quad (7)$$

where

$$A(q, \theta) = 1 + c_1 q^{-1} + c_2 q^{-2} + \dots + c_n q^{-n}, \quad (8)$$

$$\theta = [c_1 \ c_2 \ c_3 \ \dots \ c_n]^T, \quad (9)$$

assumes that $y_f(t)$ is a stationary process with a rational spectrum. Additionally, $e(t)$ is equal to a linear combination of the current and past outputs. The AR model can be found by minimizing the prediction error (Ljung, 1999).

$$\epsilon_f(t, \theta) = A(q, \theta) y_f(t) \quad (10)$$

squared with respect to θ for the filtered time data. The model

$$H_n(q) = \frac{1}{A(q, \theta)} \sqrt{\lambda} \quad (11)$$

where λ is an estimate of the variance of $e(t)$ is the model that minimizes the squared prediction error and captures the non-periodic components of the fan noise measured by the pick-up microphone. This has been illustrated in Figure 7 where the Bode amplitude plot of both the power spectral density of the pick-up microphone signal and $\|H_n(q)\|^2 \lambda$ are depicted. It can be observed that

the model $H_n(q)$ only models the ground noise level of the measurable disturbance measured by the pickup microphone.

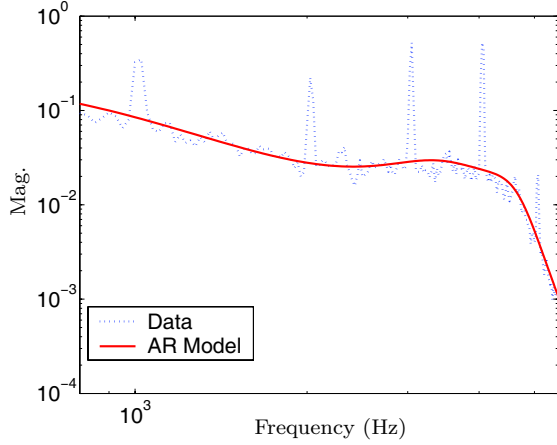

Fig. 7. Bode amplitude plot of spectral estimate of pick-up microphone signal (dotted) and AR model $\|H_n(q)\|^2 \lambda$ (solid).

5.2 Internal Model

The bode response of $W_i(q)$ that is used to design the active noise feedback controller for the HP server rack cooling fan is shown in Figure 8.

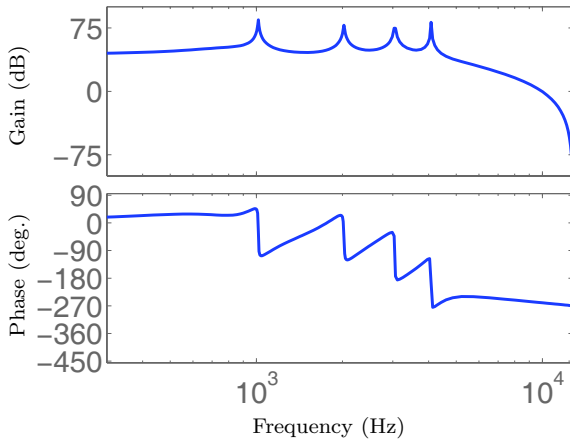

Fig. 8. The bode response of the internal model $W_i(q)$ used to cancel periodic disturbances.

It should be noted that $W_i(q)$ is used to reject only the first four harmonics of the BPF of the cooling fan. In addition, a high frequency roll-off is incorporated in $W_i(q)$ to limit the active noise control to a maximum frequency of approximately 5 kHz.

Computation of the optimal H_2 controller via the minimization of (5) leads to an 18th order stable feedback controller. The controller was reduced to 10th order controller via standard open-loop state-space balancing and truncation techniques without a noticeable difference in closed-loop H_2 -norm performance.

The Bode response of the 10th order controller $K(q)^*$ is shown in Figure 9 and it can be observed that the optimal feedback controller has the general shape of $W_i(q)$, with some additional structure and scaling to provide stability of the active noise control system.

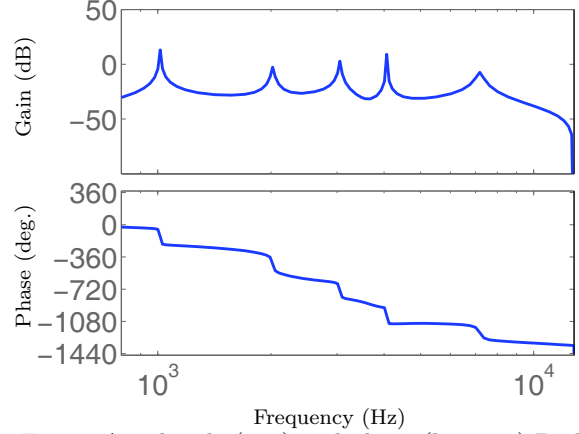

Fig. 9. Amplitude (top) and phase (bottom) Bode response of the 10th order feedback active noise control algorithm.

5.3 Experimental Results

The controller designed with the method presented in this paper was implemented in real-time on a Pentium based P.C. with a MultiQ3 12 bit signed AD/DA card. The controller has a large gain at the same frequencies as the periodic disturbances because the controller was designed to remove those periodic disturbances.

The designed noise rejection or sensitivity function

$$S(q) = \frac{1}{1 - K(q)G(q)} \quad (12)$$

is shown Figure 10. Notice, that the feedback based active noise control algorithm was designed to reject periodic disturbances at 1 KHz, 2 KHz, 3 KHz, and 4 KHz without excessive amplification of disturbances at other locations.

This phenomena is observed in the sound level measured by pick-up microphone signal when implementing the controller in real-time. The power spectral density of pick-up microphone signal without and with feedback active noise control is shown in Figure 11. As indicated by the designed sensitivity function, the controller reduces the periodic disturbances up to the level of the non-periodic components.

6. CONCLUSIONS

In this paper, the design of an H_2 optimal controller is presented that uses an internal model and an additive noise model to reject periodic disturbances. The resulting feedback controller is

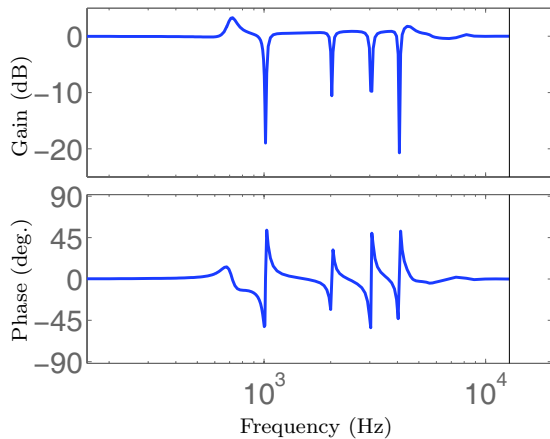

Fig. 10. Amplitude (top) and phase (bottom) Bode response of the designed sensitivity function $S(q)$ given in (12).

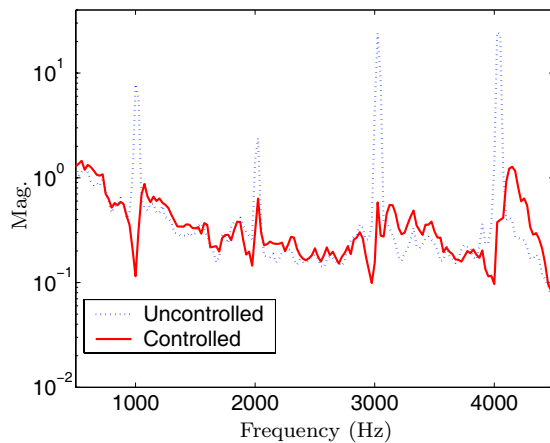

Fig. 11. Measured power spectral density of the pick-up microphone signal before (dotted) and after (solid) feedback based active noise control.

able to reject periodic disturbance components in the presence of random disturbances by an intuitive design of the internal model during the computation of the optimal controller. Instead of using a filtered memory loop inside the feedback path, similar as in repetitive control, a low order internal model of the periodic disturbance is placed in the feedback path during the control design. The use of this internal model is useful to reject known periodic disturbances, but requires a carefully design of the optimal control to avoid cancellation of the internal model during the control computations.

The application of the proposed internal model-based optimal H_2 controller design to the active noise control of a forced air-cooling system can reduce multiple harmonics of the periodic components created by the blade pass frequency of the cooling fans. An active noise cancellation application was presented to demonstrate the effectiveness of the proposed design method. The feedback controller designed for an HP rack server cooling fan was implemented in real-time and showed a significant reduction of the harmonic sound components created by a cooling fan.

REFERENCES

- K.J. Astrom and B. Wittenmark. *Computer-Controlled Systems*. Prentice-Hall, Englewood Cliff, New Jersey, 1990.
- D. De Roover, O.H. Bosgra, and M. Steinbuch. Internal-model-based design of repetitive and iterative learning controllers for linear multi-variable systems. *International Journal of Control*, 73(10):914–929, 10 July 2000.
- B.A. Francis and W.M. Wonham. The internal model principle of control theory. *Automatica*, 12(5):457–465, September 1976.
- C.T. Freeman, J.J. Hätönen, P.L. Lewin, D.H. Owens, and E. Rogers. Experimental Evaluation of a New Repetitive Control Algorithm on a Non-Minimum Phase Spring-Mass-Damper System. In *Proceedings of IFAC Workshop on Adaptation and Learning in Control and Signal Processing, and IFAC Workshop on Periodic Control Systems*, pages 681–686, Yokohama, Japan, 2004. IFAC.
- G.C. Goodwin and K.S. Sin. *Adaptive Filtering Prediction and Control*. Prentice-Hall, Englewood Cliffs, New Jersey, 1984.
- J.S. Hu. Active noise cancellation in duct using internal model-based control algorithms. *IEEE Transactions on Control Systems Technology*, 4(2):163–170, 1996.
- T. Inoue. Practical repetitive control system design. In *Proceeding of the 29th Conference on Decision and Control*, pages 1673–1678, Honolulu, Hawaii, 1990. IEEE.
- K. Satoh K. Yamada and T. Arakawa. Control Structure of All Stabilizing Repetitive Controllers for Multiple-Input/Multiple-Output Systems. In *Proceedings of IFAC Workshop on Adaptation and Learning in Control and Signal Processing, and IFAC Workshop on Periodic Control Systems*, pages 567–572, Yokohama, Japan, 2004. IFAC.
- L. Ljung. *System Identification-Theory for the User*. Prentice-Hall, Englewood Cliffs, NJ, second edition, 1999.
- J. Romeu, X. Salueña, S. Jiménez, R. Capdevila, and Ll. Coll. Active noise control in ducts in presence of standing waves. its influence on feedback effect. *Applied Acoustics*, 62(1):3–14, 2001.
- Y. Sawada and A. Ohsumi. Active attenuation of the sound outflowing from a one-dimensional duct. In *Proceedings of the 2001 IEEE International Conference on Control Applications*. IEEE, pages 1008–1013, Piscataway, NJ, USA, 2001.
- M. Steinbuch. Repetitive control for systems with uncertain period-time. *Automatica*, 38(12):2103–2109, 2002.
- I.H. Suh W.S. Chang and T.W. Kim. Analysis and design of two types of digital repetitive control systems. *Automadca*, 31(5):741–746, 1995.
- J.D. Wu and M.R. Bai. Application of feedforward adaptive active noise control for reducing blade passing noise in centrifugal fans. *Journal of Sound and Vibration*, 239(5):1051–1062, 2001.
- R. Paurobally Y.J. Wong and J. Pan. Hybrid active and passive control of fan noise. *Applied Acoustics*, 64(9):885–901, 2003.